

Linear

FLO Stem Fixture Guide

KKDÖ

Outdoor | Surface | Output up to 1159lm/m (353lm/ft)

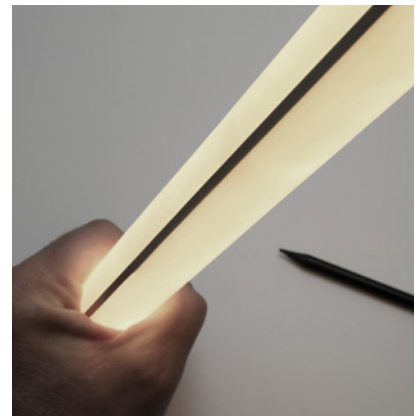

Key applications

- ✓ Direct lighting
- ✓ Gardens
- ✓ Orientation lighting
- ✓ Pathways/Driveways
- ✓ Wet area

Key features

- ✓ Custom lengths
- ✓ Constant voltage (CV)
- ✓ Decorative
- ✓ Diffusion: homogenous
- ✓ Extensive CCT range
- ✓ High impact resistance
- ✓ Illuminated ends
- ✓ IP68

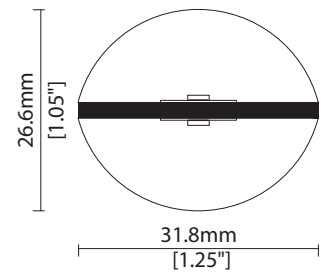

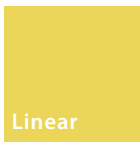

FLO Stem

Specification sheet



Dimensions	H28/W31.75/L286-1161mm (1.10/1.25/11.26-45.71in)
PCB Cut-point	62.5mm increment/2000mm max (2.46in increment/78.74in max)
LED Pitch	10.4mm - 192LED/m (0.41in - 58LED/ft)
Chip	s-line k-line
Cover/Optics	Diffused resin (130deg x2)
CCT	s-line: 1900K/2100K/2300K/2500K/2700K/3000K/3500K/4000K/5000K k-line: 1900K/2100K/2300K/2500K/2700K/3000K/3500K/4000K/5000K
LED binning	s-line: 2-step MacAdam ellipse k-line: 3-step MacAdam ellipse
CRI	88
Lifetime	50,000 hours @ 25°C (50,000 hours @ 77°F)
Operating temp	T _a = -25 to 40°C (T _c max = 75°C) T _a = -13 to 104°F (T _c max = 167°F)
IP Rating	IP68
Finish	Custom alabaster marble effect resin/Anodized aluminium
Mounting	Ground spike
Power feed	Hardwire tail
Control	0-10V/1-10V/DMX/DALI



LED Grading Key

Exclusive Grade

s **s-line***
2-step CCT range

*KKDC tuned
CCT range

Base Grade

k **k-line**
3-step commercial range
Energy Star CCTs

Power consumption	Supply voltage	Supply current
36W/m (10.97W/ft)	24V DC	1.5A/m (0.46A/ft)

Performance Data (3000K)

	R1	R2	R3	R4	R5	R6	R7	R8	R9	R10	R11	R12	R13	R14
s-line	87	90	93	88	85	86	94	80	49	77	87	64	87	96

	Diffused	CRI	R9	Rf	Rg
s-line	1159lm/m (353lm/ft) 32.2lm/W	88	49	-	-

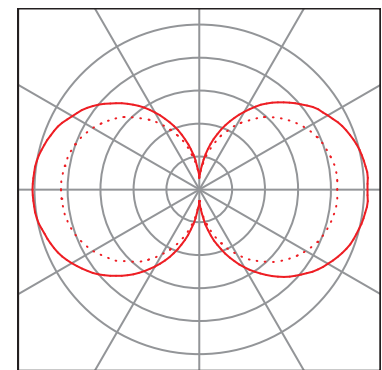
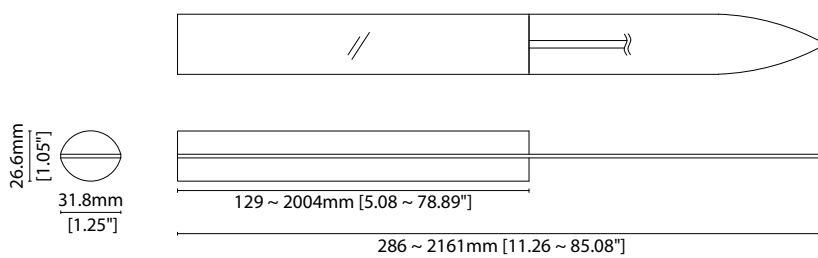

Data derived from independent UKAS / IESNA LM-79-08 accredited testing of production samples.

FLO Stem

Code Table

FIXTURE

Model	Grade ¹	LED	Colour (CCT)	Length Availability ²	IP	Cable Length	Power Feed ³	Input								
FLO Stem	FT	s	FX18	R918	1900K	19	m	129-1161mm 62.5mm increments	IP68	68	50mm (1.97in)	0050	Single ø4.3mm sheath tail	S00A	DC 24V	g
	2100K	21														
	2300K	23														
	2500K	25														
	2700K	27														
	3000K	30														
	3500K	35														
	4000K	40														
	5000K	50														

¹ Refer to **LED Grading Key** on **Specification sheet** page

² Refer to **Length Availability List** or enter total run length instead of length code

³ Refer to **Power Feed Options** on **Options** pages

Code Example:

FT	-	s	-	R918	-	35	-	m	-	599	-	68	-	0050	-	S00A	-	g
FLO Stem				FX18		3500K				599mm		IP68		50mm/1.97"		Single ø4.3mm sheath tail		DC 24V

ACCESSORIES

PSU/Driver

0-10V/1-10V/DALI/DMX

* Refer to **Driver/PSU Options** page for details or provide requirement and KKDC to offer the suitable option

Linear

FLO Stem Options

KKDC

POWER FEED OPTIONS

* Options are an integral part of the fixture ordering codes. Please refer to **Code Table** pages.

0300 S00A 300mm (11.81") Single \varnothing 4.3mm sheath tail

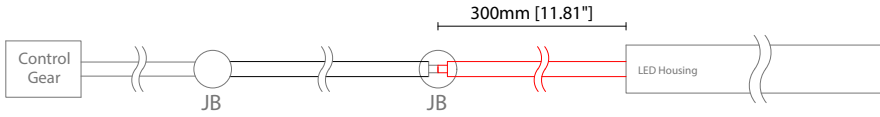

Key

Control Gear Power supply, sub-controllers & control systems
JB Junction box / cable connection

FLO Stem Length Availability List



Length Code		Fixture Length ¹		LED Strip ²		End Cap Dimension		Wattage (W)	Output (lm)
Metric	Imperial(US)	Metric	Imperial(US)	Metric	Imperial(US)	Metric	Imperial(US)		3000K (Test Data)
m0169	i0007	286mm	11.26in	125mm	4.92in	N/A	N/A	4.50	144
m0232	i0009	349mm	13.72in	188mm	7.38in	N/A	N/A	6.75	216
m0294	i0012	411mm	16.18in	250mm	9.84in	N/A	N/A	9.00	288
m0357	i0014	474mm	18.64in	313mm	12.30in	N/A	N/A	11.25	360
m0419	i0016	536mm	21.10in	375mm	14.76in	N/A	N/A	13.50	432
m0482	i0019	599mm	23.56in	438mm	17.22in	N/A	N/A	15.75	504
m0544	i0021	661mm	26.02in	500mm	19.69in	N/A	N/A	18.00	576
m0607	i0024	724mm	28.48in	563mm	22.15in	N/A	N/A	20.25	648
m0669	i0026	786mm	30.94in	625mm	24.61in	N/A	N/A	22.50	720
m0732	i0029	849mm	33.41in	688mm	27.07in	N/A	N/A	24.75	792
m0794	i0031	911mm	35.87in	750mm	29.53in	N/A	N/A	27.00	864
m0857	i0034	974mm	38.33in	813mm	31.99in	N/A	N/A	29.25	936
m0919	i0036	1036mm	40.79in	875mm	34.45in	N/A	N/A	31.50	1008
m0982	i0039	1099mm	43.25in	938mm	36.91in	N/A	N/A	33.75	1080
m1044	i0041	1161mm	45.71in	1000mm	39.37in	N/A	N/A	36.00	1152

¹ Actual total overall length of light fixture

² Actual length of PCB strip

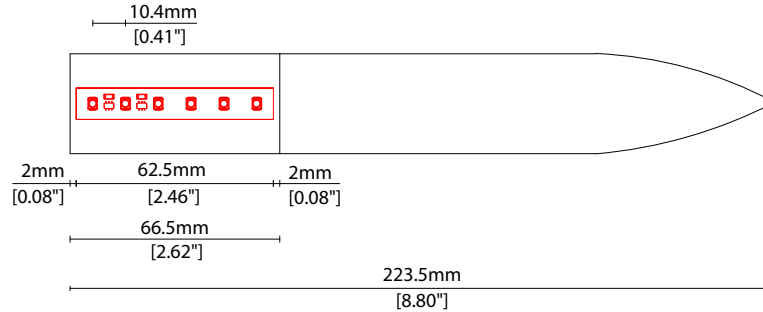

KKDC CONTROL



IP20
Plastic housing
L170/W59/H29mm
(L6.69/W2.32/H1.14in)

KKDM-06 1-10V

visDIM dimmable sub-controller
(4 x 8A max @ 12-36V)



IP20
Plastic housing
L170/W53.4/H28mm
(L6.69/W2.10/H1.10in)

KKSC-05 DMX

visDIM dimmable sub-controller
(4 x 5A max @ 12-36V)



IP20
Plastic housing
L170/W59/H29mm
(L6.69/W2.32/H1.14in)

KKDL-02 DALI

visDIM dimmable sub-controller
(4 x 8A max @ 12-36V)



IP20
Plastic housing
L166/W53.4/H23mm
(L6.54/W2.10/H0.91in)

KKDL-03 DALI

visDIM dimmable sub-controller
(4 x 5A max @ 12-36V)

AVAILABLE PSU OPTIONS

Control Mode	PSU (Order Code)	Input Voltage AC	Output Voltage DC	Rated Output Current	Rated Power	Dim %	IP Rating
Switched	CEN-60-24	90-295V	24V	2.5A	60W	-	IP67
	HLG-60H-24	90-305V	24V	2.5A	60W	-	IP67
	HLG-100H-24	90-305V	24V	4.0A	100W	-	IP67
	HLG-150H-24	90-305V	24V	6.3A	150W	-	IP67
	HLG-240H-24	90-305V	24V	10A	240W	-	IP67
0-10V (1-10V)	PWM-40-24	90-305V	24V	1.67A	40W	100-0.15 (100-10)	IP67
	PWM-60-24	90-305V	24V	2.5A	60W	100-0.15 (100-10)	IP67
	PWM-90-24	90-305V	24V	3.67A	90W	100-0.15 (100-10)	IP67
	PWM-120-24	90-305V	24V	5.0A	120W	100-0.15 (100-10)	IP67
DALI	LIN100A1	120-277V	24V	1A per channel	100W	100-0.1	IP66/IP40
DMX RGB	LIN100A1	120-277V	24V	1.33A per channel	100W	100-0.1	IP66/IP40
DMX RGBW	LIN100A1	120-277A	24V	1A per channel	100W	100-0.1	IP66/IP40

Flicker Free Options - Combination of PSU+ sub-controller

Control Mode	PSU (Order Code)	Sub-controller (Order Code)	Input Voltage AC	Output Voltage DC	Rated Output Current	Rated Power	Dim %	IP Rating PSU/ Sub-controller
0-10V or 1-10V	CEN-60-24	KKDM-06	90-295V	24V	2.5A	60W	100-0.9	IP67/IP20
	HLG-60H-24	KKDM-06	90-295V	24V	2.5A	60W	100-0.9	IP67/IP20
	HLG-100H-24	KKDM-06	90-295V	24V	4.0A	100W	100-0.9	IP67/IP20
	HLG-150H-24	KKDM-06	90-295V	24V	6.3A	150W	100-0.9	IP67/IP20
	HLG-240H-24	KKDM-06	90-295V	24V	10.0A	240W	100-0.9	IP67/IP20
DALI	CEN-60-24	KKDL-02/03	90-295V	24V	2.5A	60W	100-0.1	IP67/IP20
	HLG-60H-24	KKDL-02/03	90-305V	24V	2.5A	60W	100-0.1	IP67/IP20
	HLG-100H-24	KKDL-02/03	90-305V	24V	4.0A	100W	100-0.1	IP67/IP20
	HLG-150H-24	KKDL-02/03	90-305V	24V	6.3A	150W	100-0.1	IP67/IP20
	HLG-240H-24	KKDL-02/03	90-305V	24V	10.0A	240W	100-0.1	IP67/IP20
DMX RGB	CEN-60-24	KKSC-05	90-295V	24V	2.5A	60W	100-0.9	IP67/IP20
	HLG-60H-24	KKSC-05	90-305V	24V	2.5A	60W	100-0.9	IP67/IP20
	HLG-100H-24	KKSC-05	90-305V	24V	4A	100W	100-0.9	IP67/IP20
	HLG-150H-24	KKSC-05	90-305V	24V	6.3A	150W	100-0.9	IP67/IP20
	HLG-240H-24	KKSC-05	90-305V	24V	10.0A	240W	100-0.9	IP67/IP20

¹ The items shown above cover the most frequently used specification but does not exhaust the possible options

² PSU and/or driver can be chosen from the table, or KKDC may recommend the best option upon receipt of the controls requirement and installation environment

³ Electrical shop drawing will include detailed information of PSU and relevant control drivers

⁴ Cut sheets are available on the controls section of www.kkdc.lighting or upon request